

Article number: 20112020

Description: E+G Revolving handle
DIN 98-KT-20-E

Measures

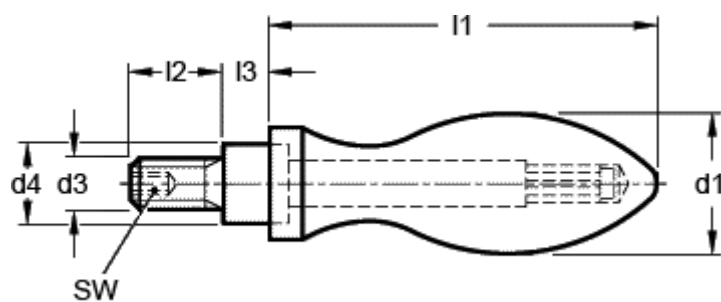

d1	= 20
d3	= M8
d4 h13	= 13
l1 approx.	= 61
l2	= 13
l3	= 6.0
SW	= 4